

A LEADING MANUFACTURER IN LINEAR MOTION

GERALD SUMMERS is now an authorised distributor of Rollon

SUMMERS

TEL: 0800 055 6663

E-MAIL: SALES@GERALD-SUMMERS.CO.UK

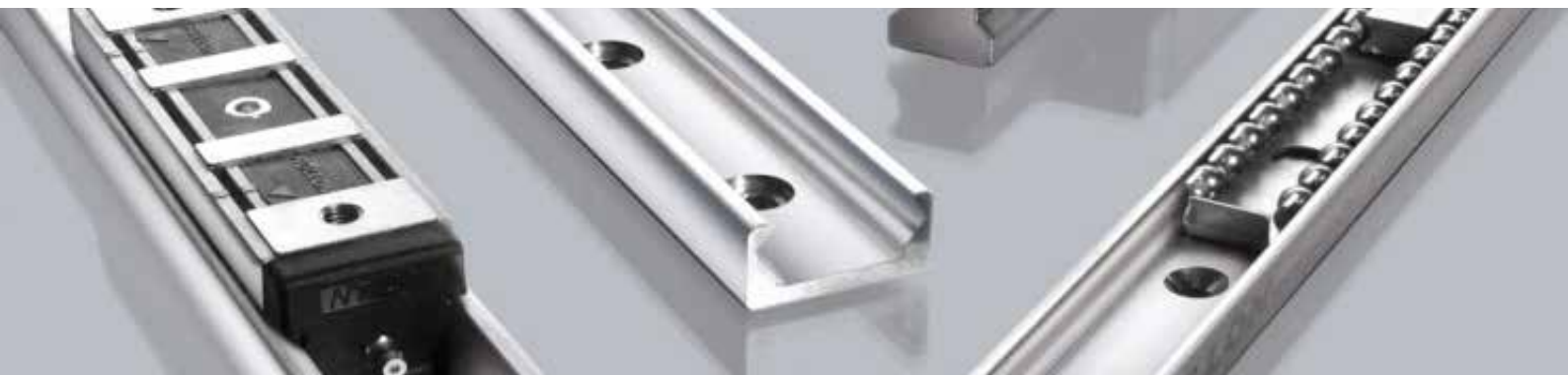

LIGHT RAIL



About Rollon



Development of global business

- 1975** Parent company, Rollon S.r.l., founded in Italy
- 1991** Founding of Rollon GmbH in Germany
- 1995** Expansion of headquarters to new 4,000 m² factory
Assembly starts in Germany
Quality management certified to ISO 9001
- 1998** Rollon B.V. in the Netherlands and Rollon Corporation in the USA are founded
Expansion of German branch to new 1,000 m² plant
- 1999** Founding of Rollon S.A.R.L. in France
Environmental management certified to ISO 14001
- 2000** Rollon s.r.o. founded in Czech Republic
- 2001** Expansion of headquarters to new 12,000 m² manufacturing plant
- 2007** Restructuring of the GmbH and alignment of production in Germany to customer-specific adaptations
Takeover of the assets of a manufacturer of linear rail systems
- 2008** Expansion of sales network in Eastern Europe and Asia

Continual expansion and optimization of the portfolio

Founded in 1975, Rollon manufactured high-precision linear roller bearings for the machine tool industry. Early on, Rollon started manufacturing linear bearings based on the bearing-cage design. In 1979, the Compact Rail self-aligning linear bearings joined the Telescopic Rail industrial drawer slides and Easy Rail linear bearings and became the basis of the strong foundation on which the company is building upon today. Continuing optimization of these core products still remains one of the most important goals at Rollon. The development of the patented Compact Rail linear bearing, which uses different proprietary rail profiles and high-precision radial ball bearing sliders, enables the compensation of height and angle mounting defects in applications, and is only one example of the continuing efforts to innovative the development of our existing product families. In the same manner, we continually introduce innovative new product families displaying our continuing product development and optimization in the industry. These include:

- 1994 Light Rail - full and partial extension telescopic in lightweight design
- 1996 Uniline - belt driven linear actuators
- 2001 Ecoline - economical aluminum linear actuators
- 2002 X-Rail - inexpensive formed steel linear guides
- 2004 Curviline - curved monorail profile rail guide with roller carriages
- 2007 Monorail - miniature sizes and full sized

Each further innovation of our linear bearings is built upon the our extensive knowledge of the nine product families in production today as well as on the current market demands. Rollon is the ultimate linear technology for any application needs.

Content

1 Product explanation	
Full and partial extension in lightweight design	4
2 Technical data	
Performance characteristics and remarks	6
3 Product dimensions	
LPS 38	7
LFS 46	8
LFS 57	9
LFS 58 SC	10
LFS 70	11
4 Technical instructions	
Load capacities	12
Speed, Temperature, Lubrication, Corrosion protection	13
Installation instructions	14

Ordering Key

Ordering key with explanations

Portfolio

Product explanation

Light Rail: Full and partial extensions in lightweight design



Fig. 1

The Light Rail product family consists of five series with full and partial extensions in lightweight design. It is ideal for applications in which the mass of the rail is just as important as the bending rigidity.

The most important characteristics:

- Light and quiet running with heavy loads
- Long service life without maintenance
- Effective self-cleaning of the ball track
- High functional reliability
- Structural elasticity capable of absorbing minor impacts and absence of permanent deformation
- Not sensitive to side impacts

Preferred areas of application:

- Beverage industry
- Automotive
- Construction and machine technology (e.g., housing)
- Packaging machines
- Railcars (e. g., maintenance and battery extensions)
- Special machines

LPS 38

Partial extension with rails made of hot-dipped galvanized steel and plastic ball cages.



Fig. 2

LFS 46

Detachable internal rail which can be released with a latch. Rails are made of bright chrome-plated steel, the ball cages of steel and plastic. Roll back protection in closed position.



Fig. 3

LFS 57

Full extension with rails made of hot-dipped galvanized steel and zinc-plated steel ball cages. Roll back protection in closed position.



Fig. 4

LFS 58 SC

Full extension with automatic retraction and damping. The automatic retraction system is assisted by a spring-loaded mechanism that allows the rail to get back to a complete retraction before reaching the closed position.



Fig. 5

LFS 70

Full extension with rails made of zinc-plated galvanized and blue passivated steel. The ball cages are made of zinc-plated steel. Heavy load end stop in opened and closed position. Roll back protection in closed position.



Fig. 6

Technical data

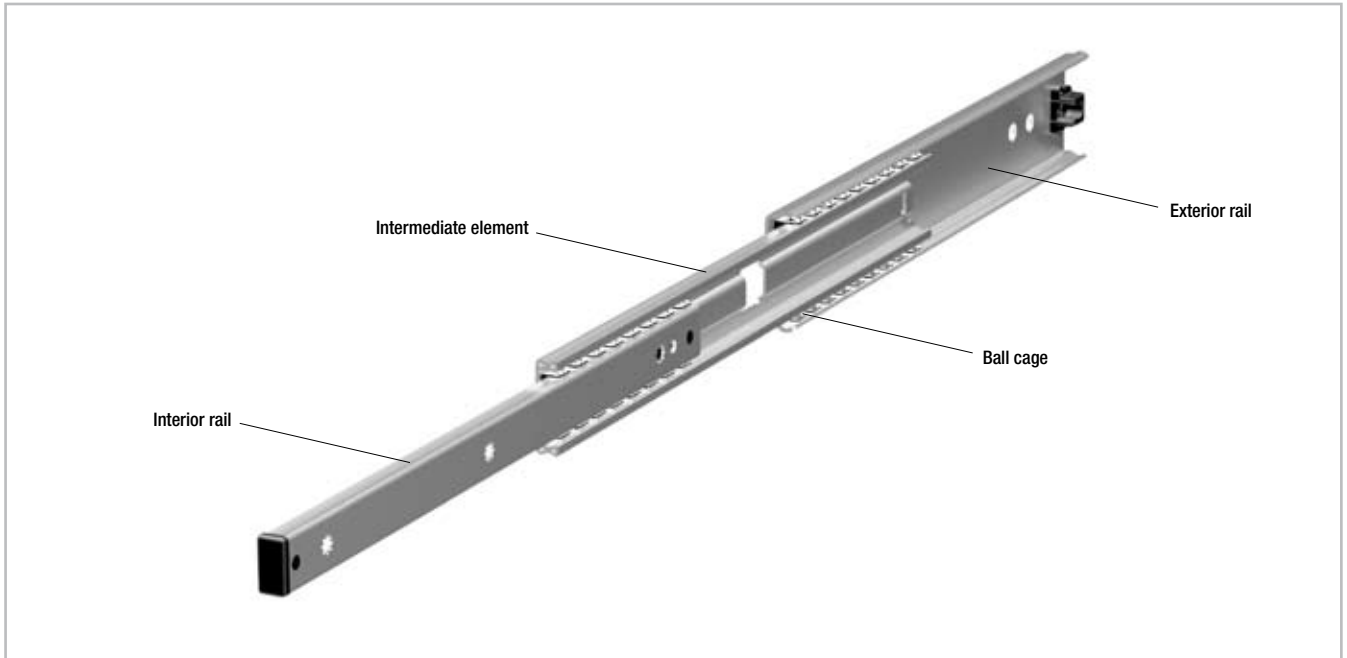

Fig. 7

Performance characteristics:

- Extension speed (depending on application):
 - Extension distance 100 - 500 mm: max. 0.5 m/s (19.69 in/s)
 - Extension distance 600 mm: max. 0.4 m/s (15.75 in/s)
 - Extension distance 700 mm: max. 0.3 m/s (11.81 in/s)
- LFS 58 SC series with automatic retraction
- Temperature range: +10 °C to +40 °C (+50 °F to +104 °F)
Temporary storage and transport temperature:
-20 °C to max. +80 °C (-4 °F to +176 °F)
- All systems are lubricated for life
- Rail material: hot-dipped galvanized steel or chromated steel
- Ball cage material: zinc-plated steel or plastic
- Ball material: hardened carbon steel

Remarks:

- Assembly in cross-sectional width, here a positive tolerance of +0.5 mm is recommended (mounted under tension). If the extensions are installed with too small a tolerance, the service life is decreased
- Load capacity is per single rail (not per pair)
- Cycle data applies to the use of an extension pair (recommended)
- Vertical use of extensions (radial load) is recommended
- The load capacity is reduced with horizontal installation (see pg. 12)
- Cathodic edge protection, additional corrosion protection with powder coating on request
- Roll back protection in closed position is friction locked (except LPS 38)
- Not suitable for moments – must be used as extension pair

Product dimensions

LPS 38

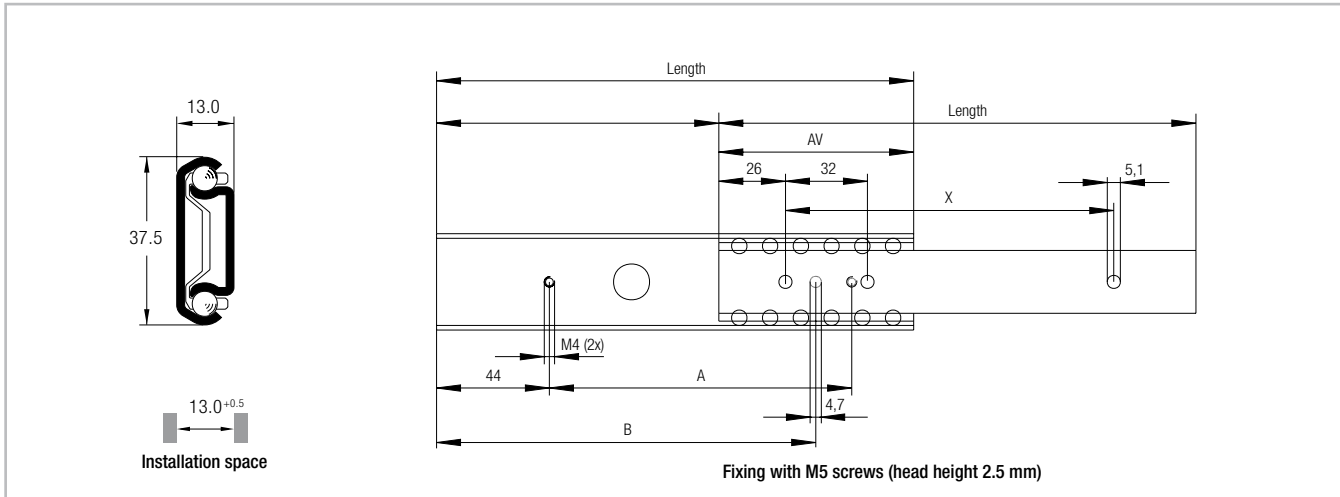

All dimensions given in mm

Fig. 8

Type	Size	Length [mm]	Extension loss AV [mm]	Stroke* [mm]	A [mm]	B [mm]	X [mm]	Load capacity**		Weight** [kg]
								C_{0rad} [N]	C_{0ax} [N]	
LPS	38	242	88	154	166	202	192	175	50	0.30
		317		229	241	277	256			0.40
		398	100	298	322	358	352			0.50
		473		373	397	433	416			0.60

* The stroke is the difference of the length, minus the extension loss AV
 ** The given load capacities and weights apply for a single extension

Tab. 1

Note: The given load capacities are guidelines with 100,000 cycles and uniform load distribution (area load) when using all mounting holes. The load values must be reduced in unfavorable conditions.

LFS 46

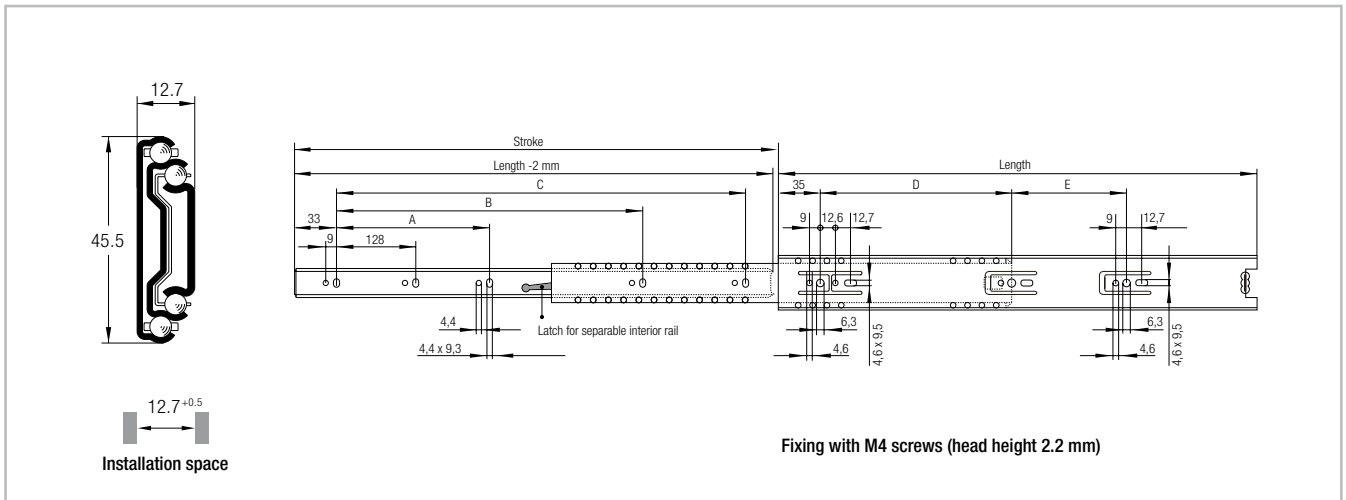

All dimensions given in mm

Fig. 9

Type	Size	Length	Stroke	A	B	C	D	E	Load capacity*	Load capacity*	Weight*
		[mm]	[mm]	[mm]	[mm]	[mm]	[mm]	[mm]	C_{0rad} [N]	C_{0ax} [N]	
LFS	46	300	305	-	-	242	192	-	150	50	0.48
		400	406	-	-	342	160	96	0.64		
		450	457	-	256	392		160	175		0.71
		500	508	-	352	442	224	128	200	0.79	
		550	559	-	416	492		192		0.88	
		600	610	224	416	542		224		0.95	

* The given load capacities and weights apply for a single extension

Tab. 2

Note: The given load capacities are guidelines with 80,000 cycles and uniform load distribution (area load) when using all mounting holes. The load values must be reduced in unfavorable conditions.

LFS 57

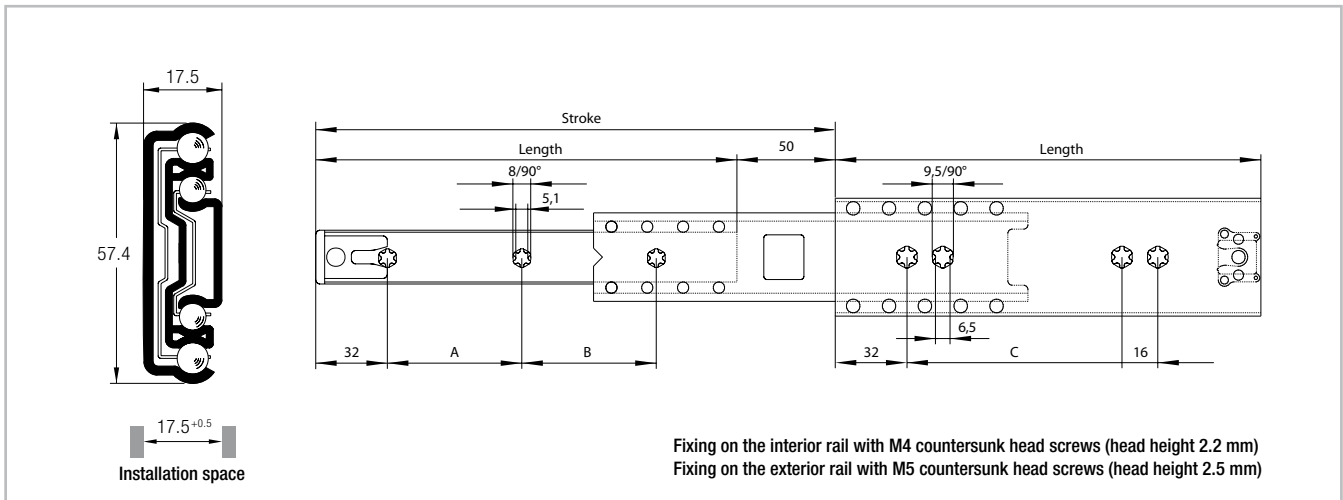

All dimensions given in mm

Fig. 10

Type	Size	Length	Stroke*	A	B	C	Load capacity**		Weight**
		[mm]	[mm]	[mm]	[mm]	[mm]	C_{0rad} [N]	C_{0ax} [N]	
LFS	57	300	350	128	104	160	250	80	0.84
		350	400		152				0.98
		400	450	160	168	256	325	80	1.13
		450	500		224				1.27
		500	550	224	208	384	375	80	1.42
		550	600		256				1.57
		600	650	288	240	384	400	80	1.71
		650	700		288				1.86
		700	750	320	312	384	400	80	2.01
		750	800		360				2.16

* The stroke is the sum of the length, and the over extension
 ** The given load capacities and weights apply for a single extension

Tab. 3

Note: The given load capacities are guidelines with 100,000 cycles and uniform load distribution (area load) when using all mounting holes. The load values must be reduced in unfavorable conditions.

LFS 58 SC

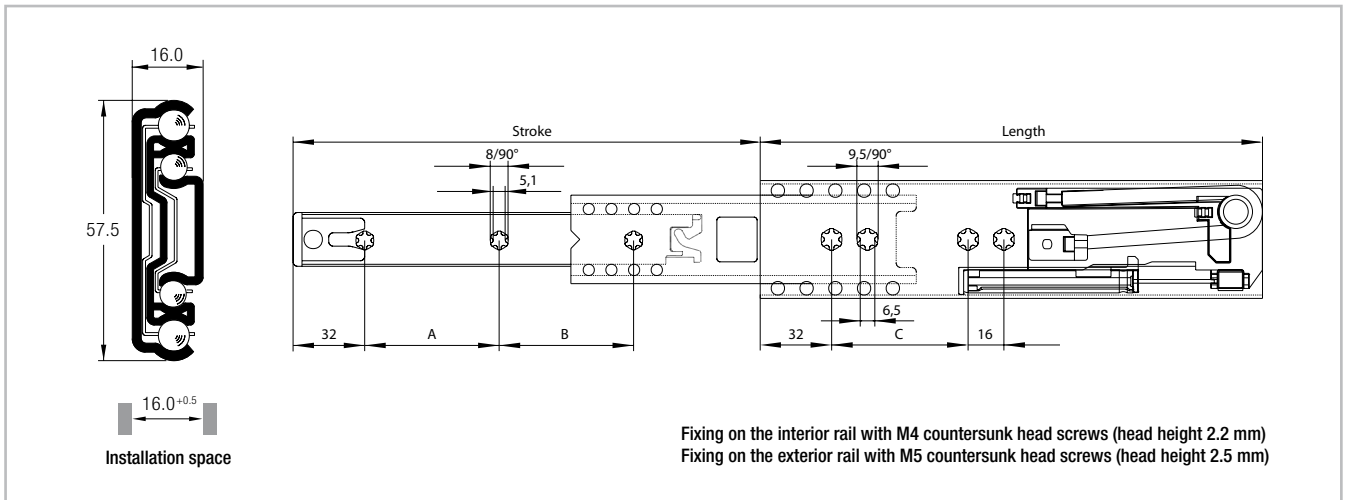

All dimensions given in mm

Fig. 11

Type	Size	Length	Stroke	A	B	C	Load capacity*	Weight*
		[mm]	[mm]	[mm]	[mm]	[mm]	C_{Orad} [N]	[kg]
LFS	58	400	434	128	128	224	200	1.10
		450	484	160	160	256	250	1.25
		500	534				192	320
		550	584	300	1.55			

* The given load capacities and weights apply for a single extension

Tab. 4

Note: The given load capacities are guidelines with 100,000 cycles and uniform load distribution (area load) when using all mounting holes. The load values must be reduced in unfavorable conditions. Horizontal installation is not possible due to the damping system. The damping effect is reduced for loads of 450 N and higher per extension pair.

LFS 70

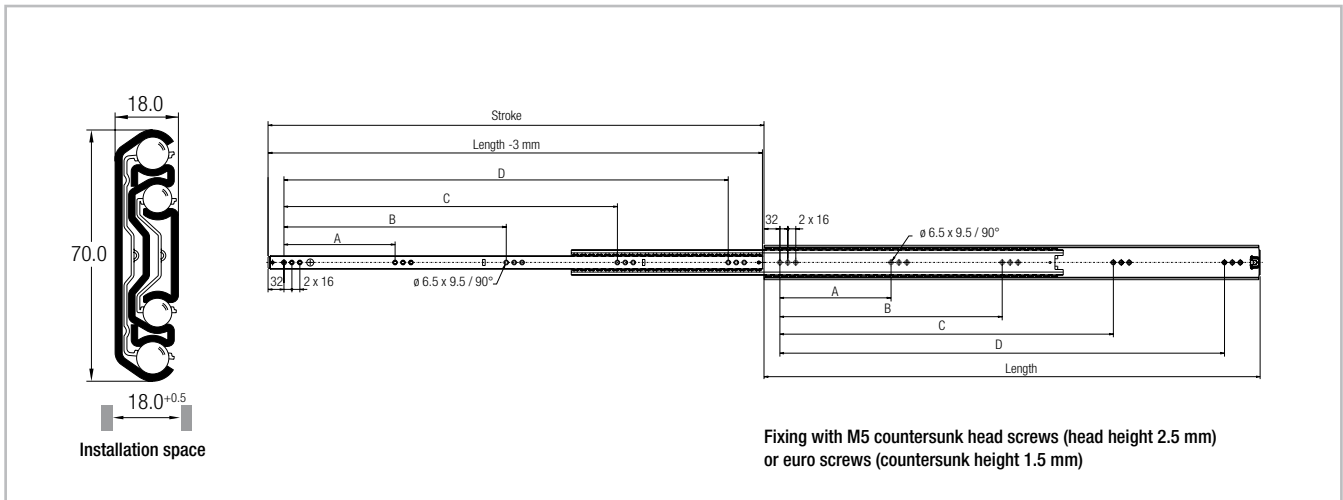

All dimensions given in mm

Fig. 12

Type	Size	Length	Stroke	A	B	C	D	Load capacity*	Load capacity*	Weight*
		[mm]	[mm]	[mm]	[mm]	[mm]	[mm]	C_{0rad} [N]	C_{0ax} [N]	
LFS	70	400	400	-	-	-	288	525	150	1.55
		450	450	-	-	160	320	575		1.74
		500	500	-	-	192	384	650		1.94
		550	550	-	-	224	448			2.13
		600	600	-	-					2.32
		700	700	-	192	384	576	600		2.70
		800	800	-	224	448	672	450		3.10
		1100	1100	224	448	672	896		100	4.25

* The given load capacities and weights apply for a single extension

Tab. 5

Note: The given load capacities are guidelines with 100,000 cycles and uniform load distribution (area load) when using all mounting holes. The load values must be reduced in unfavorable conditions.

Technical instructions

Load capacities

Vertical installation (radial load)

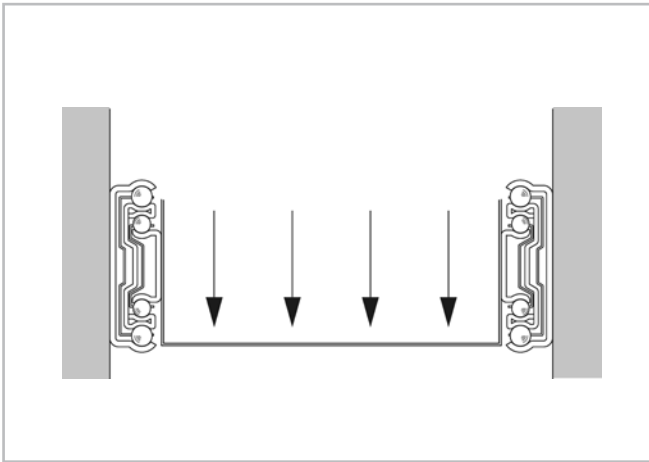

Fig. 13

The given loading capacities are guidelines for an extension rail vertically mounted with uniform load distribution using all mounting holes. The load values must be reduced in unfavorable conditions.

Horizontal installation (axial load)

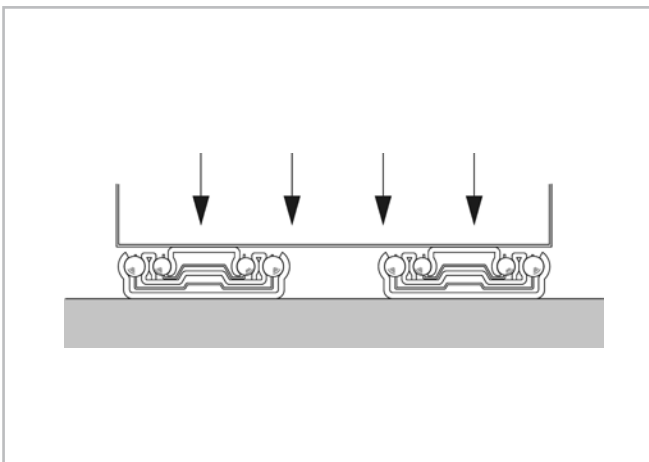

Fig. 14

For horizontal mounted extensions the load capacity is reduced (see pg. 7ff, tab. 1 to tab. 5).

Speed

The extension speed is determined by the size of the intermediate elements. Therefore, the maximum extension speed is inversely proportional to the overall extension of the rails (see fig. 15). The maximum extension speed is also directly related to the applied load and operating time. The indicated data refers to continuous operation at the maximum load capacity.

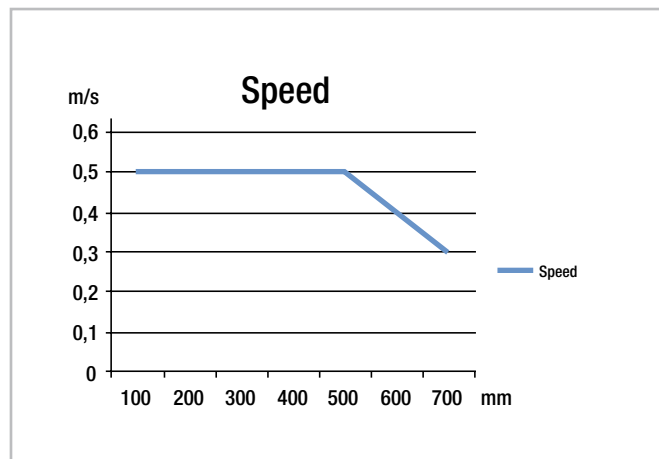

Fig. 15

Temperature

Continual operating temperature of the Light Rail extensions is +10 °C to +40 °C. Temporary storage and transport temperature: -20 °C to max. +80 °C.

For more information please contact the Rollon Application engineering department.

Lubrication

All extensions of the Light Rail product family are lubricated for life. Different lubricants for special applications are available upon request. Example: Lubricant with FDA approval for use in the food industry.

For more information please contact the Rollon Application engineering department.

Corrosion protection

Base material for the Light Rail product family is cold-rolled, hot-dipped galvanized steel. The cathodic edge protection offers a perfect combination of quality and cost-efficiency. The surface protection conforms to RoHS.

For more information please contact the Rollon Application engineering department.

Installation instructions

- The existing internal stops are not designed to stop the moving load. They are only supposed to retain the ball-cage and prevent the internal parts to slide out of the assembly. An external end-stop must always be installed to stop the moving load.
- To achieve optimum running properties, high service life and rigidity, it is necessary to fix the Light Rail extensions with all accessible holes on a rigid and level surface. When using an extension pair, please observe the parallelism of the installation surfaces. The fixed and movable rails fit to the rigid assembly construction.
- Light Rail full and partial extensions are suitable for use in automatic

systems. For this, the stroke should remain constant in all moving cycles and the extension speed must be checked (see pg. 13, fig. 15). The movement of the extensions is enabled by internal ball cages, which could experience an offset from the original position with differing strokes. This phase offset can have a negative effect on the running properties or limit the stroke. If differing strokes occur in an application, the drive force must be sufficiently dimensioned in order to appropriately synchronize the ball cage offset. As an alternative, an extra full stroke cycle can be performed every certain number of cycles, in order to re-phase the ball cage in its correct position.

Horizontally installed guides

Horizontally installed extensions can support tension or compression loads (see figs. 16 and 17).

For the horizontal mounting of extensions with compression loads, please keep the following conditions into account: The Hertzian stress of the balls in no longer effective due to the expansion of the rail profile; the nominal tension tolerance of +0.5 mm is eliminated due to the installation configuration. Both the above mentioned conditions contribute to a significant reduction of the axial load capacity.

Horizontally-mounted rails (axial load) also determine a considerably higher deflection of the extended tips if compared to traditionally vertically-mounted rails (radial load).

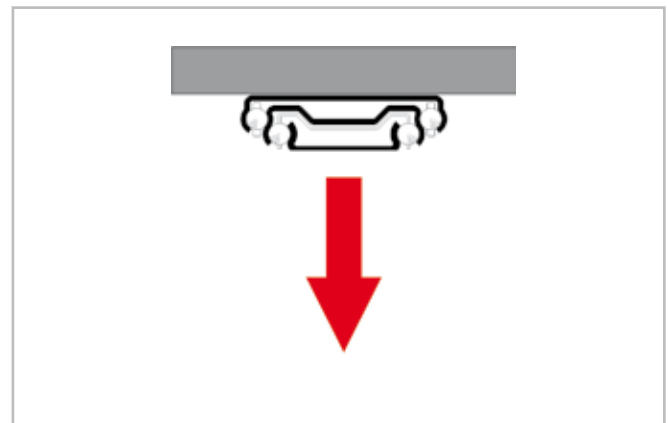

Fig. 16

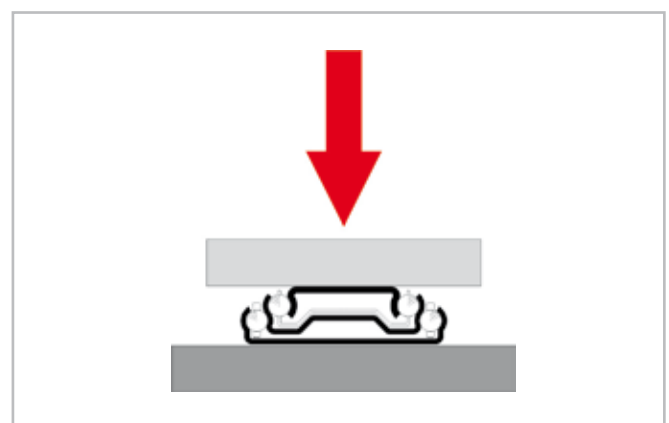

Fig. 17

Portfolio



COMPACT RAIL

Rugged roller sliders with innovative self adjustment



MONO RAIL

Profile guideways for highest degrees of precision



CURVILINE

Curvilinear rails for constant and variable radii



MINIATURE MONO RAIL

Miniature format profile guideways with unique ball design

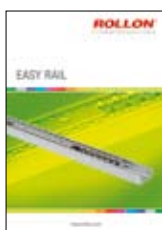

EASY RAIL

Compact, versatile linear bearings



TELESCOPIC RAIL

Smooth-running telescopic linear bearing drawer slides with low deflection under heavy loads



UNILINE

Steel-reinforced, belt-driven linear actuators with hardened steel linear bearings and precision radial ball bearing rollers



X-RAIL

Roller embossed stainless steel profiles for the use in rough environments

Ordering key

Telescopic rails

LFS	58-	400	SC	
			Automatic retraction only in LFS 58 SC	<i>see pg. 10</i>
			Rail length in mm	
	Size			
Rail type				

Ordering example: LFS58-0400SC

Notes on ordering: The rail lengths are always indicated as 4 digits with 0 prefixes

Fold out ordering key

To make this product catalog as simple as possible for you to use, we have included the following easy-to-read chart.

Your advantages:

- Description and ordering designations easy to read at one glance
- Simplified selection of the correct product
- Links to detailed descriptions in the catalog



Italy

ROLLON S.r.l.

Via Trieste 26
I-20871 Vimercate (MB)
Tel.: (+39) 039 62 59 1
Fax: (+39) 039 62 59 205
E-Mail: infocom@rollon.it
www.rollon.it

Germany

ROLLON GmbH

Bonner Strasse 317-319
D-40589 Düsseldorf
Tel.: (+49) 211 95 747 0
Fax: (+49) 211 95 747 100
E-Mail: info@rollon.de
www.rollon.de

France

ROLLON S.A.R.L.

Les Jardins d'Eole, 2 allée des Séquoias
F-69760 Limonest
Tel.: (+33) (0)4 74 71 93 30
Fax: (+33) (0)4 74 71 95 31
E-Mail: infocom@rollon.fr
www.rollon.fr

Netherlands

ROLLON B.V.

Ringbaan Zuid 8
6905 DB Zevenaar
Tel.: (+31) 316 581 999
Fax: (+31) 316 341 236
E-Mail: info@rollon.nl
www.rollon.nl

USA

ROLLON Corporation

101 Bilby Road. Suite B
Hackettstown, NJ 07840
Tel.: (+1) 973 300 5492
Fax: (+1) 908 852 2714
E-Mail: info@rolloncorp.com
www.rolloncorp.com

All addresses of our global sales partners can also be found in the internet at www.rollon.com